

# Skabelonoversigt til Zipper Wall messevæg

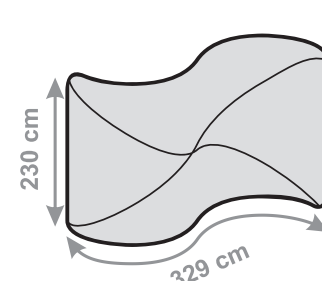
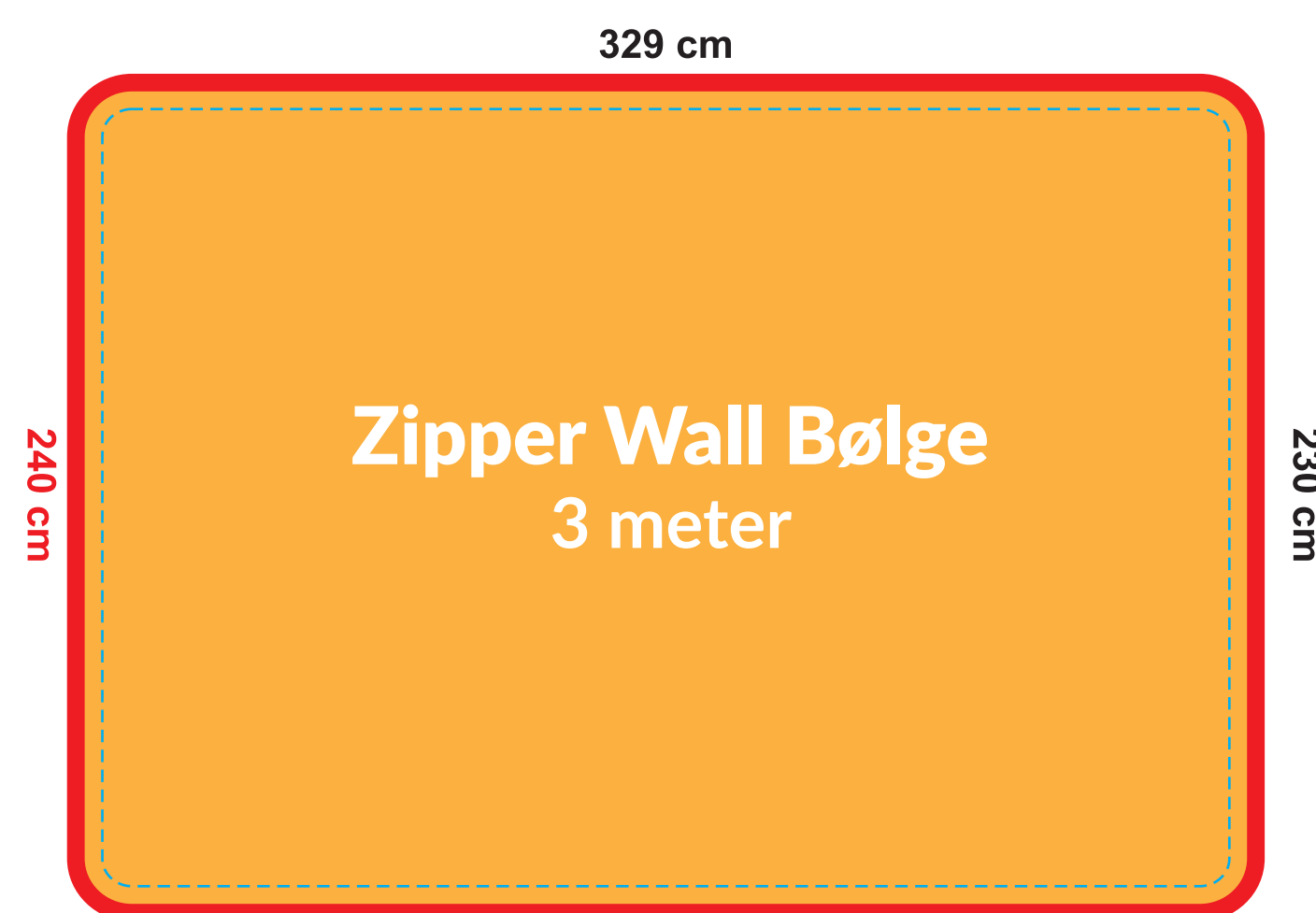
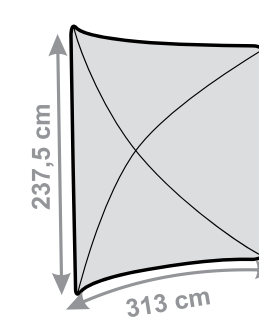
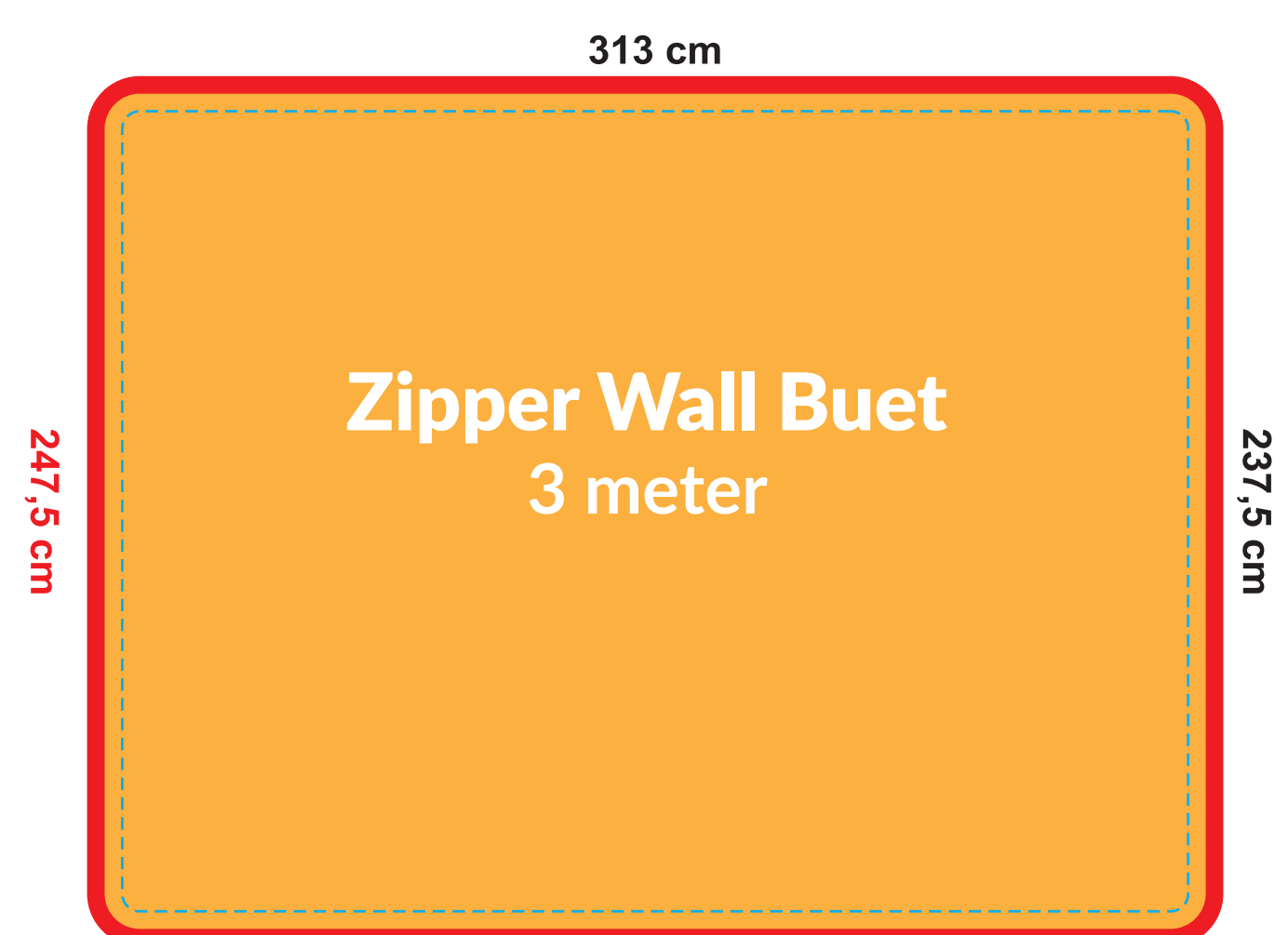
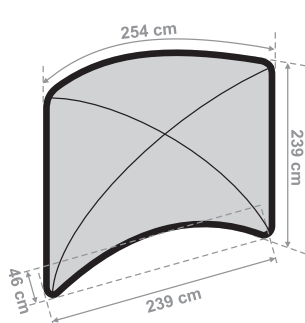
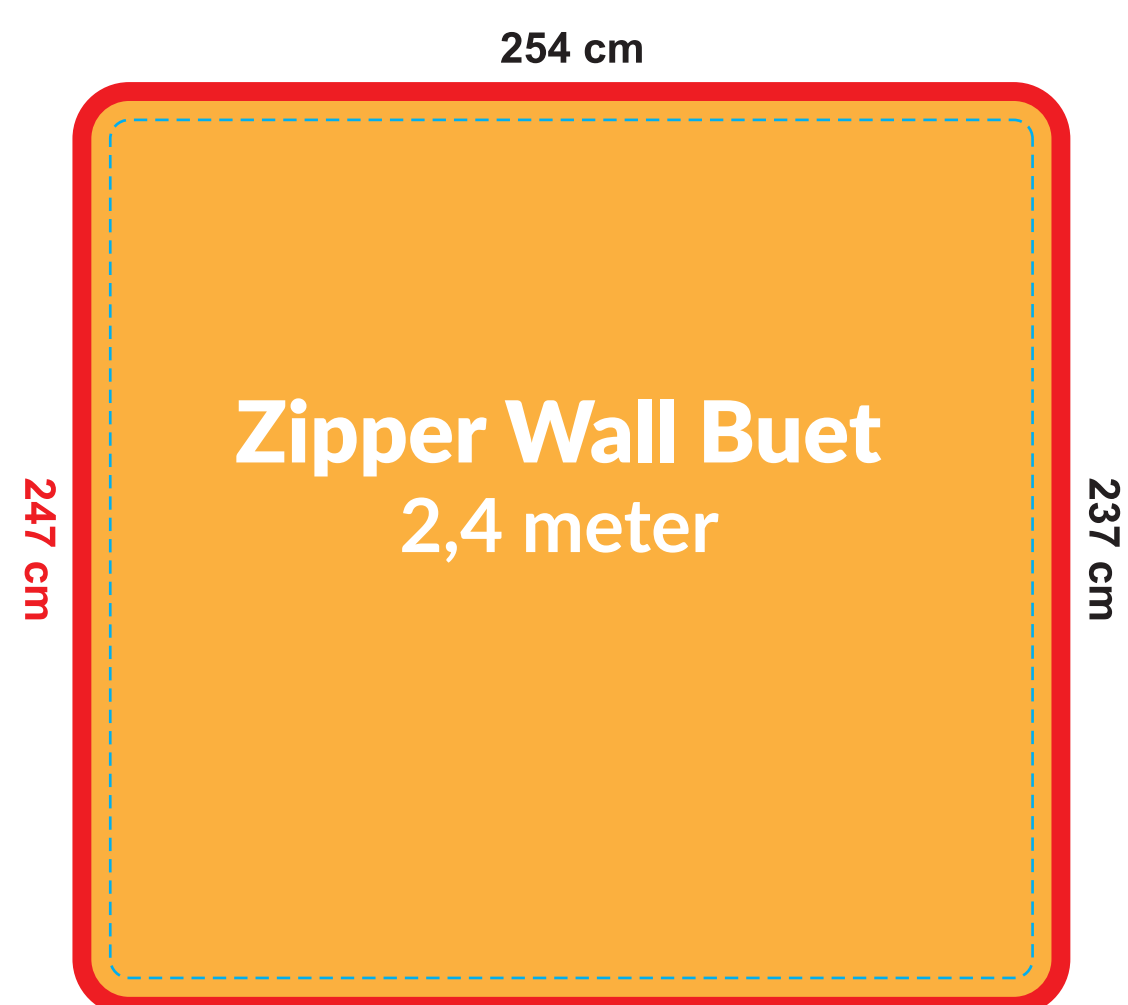
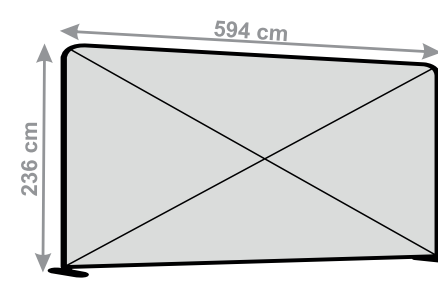
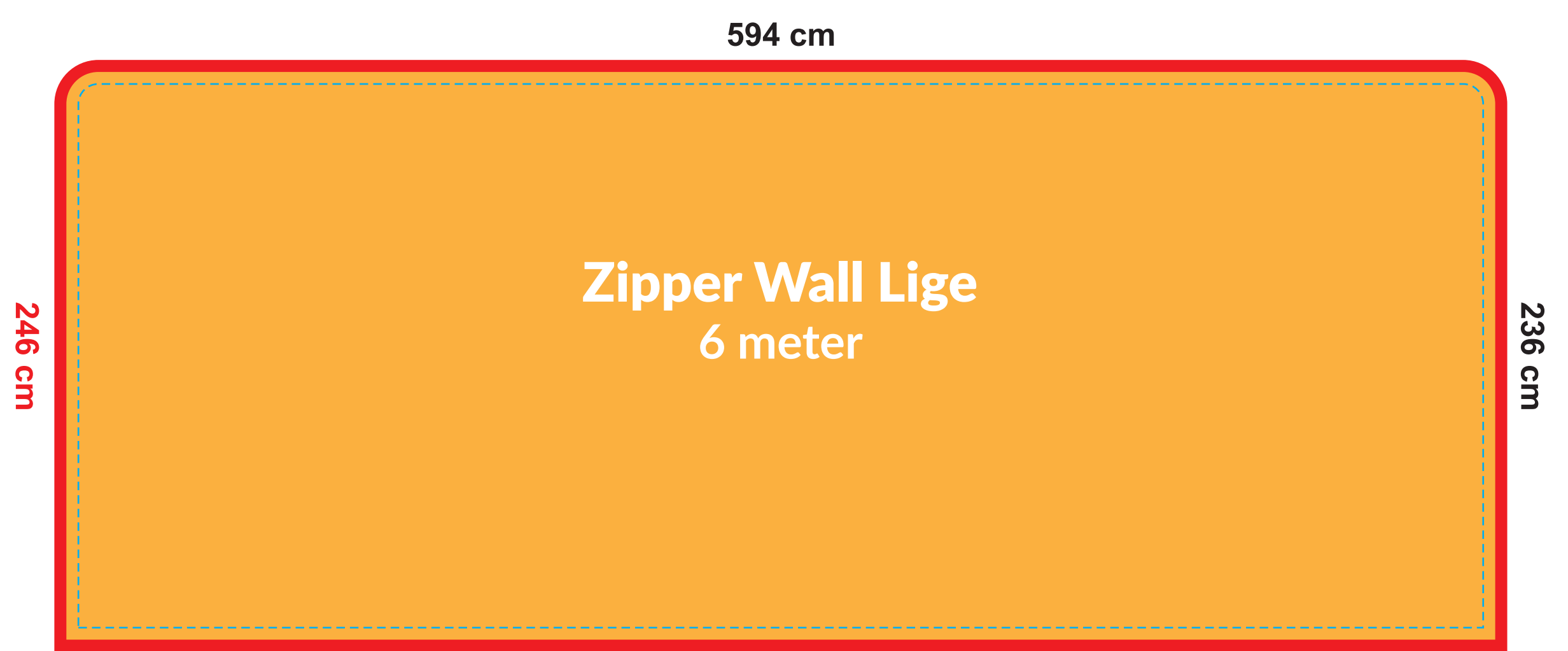
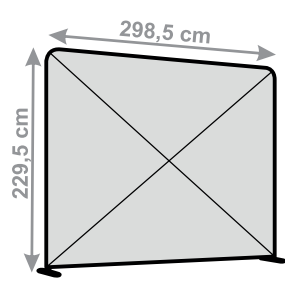
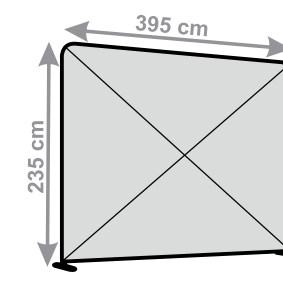
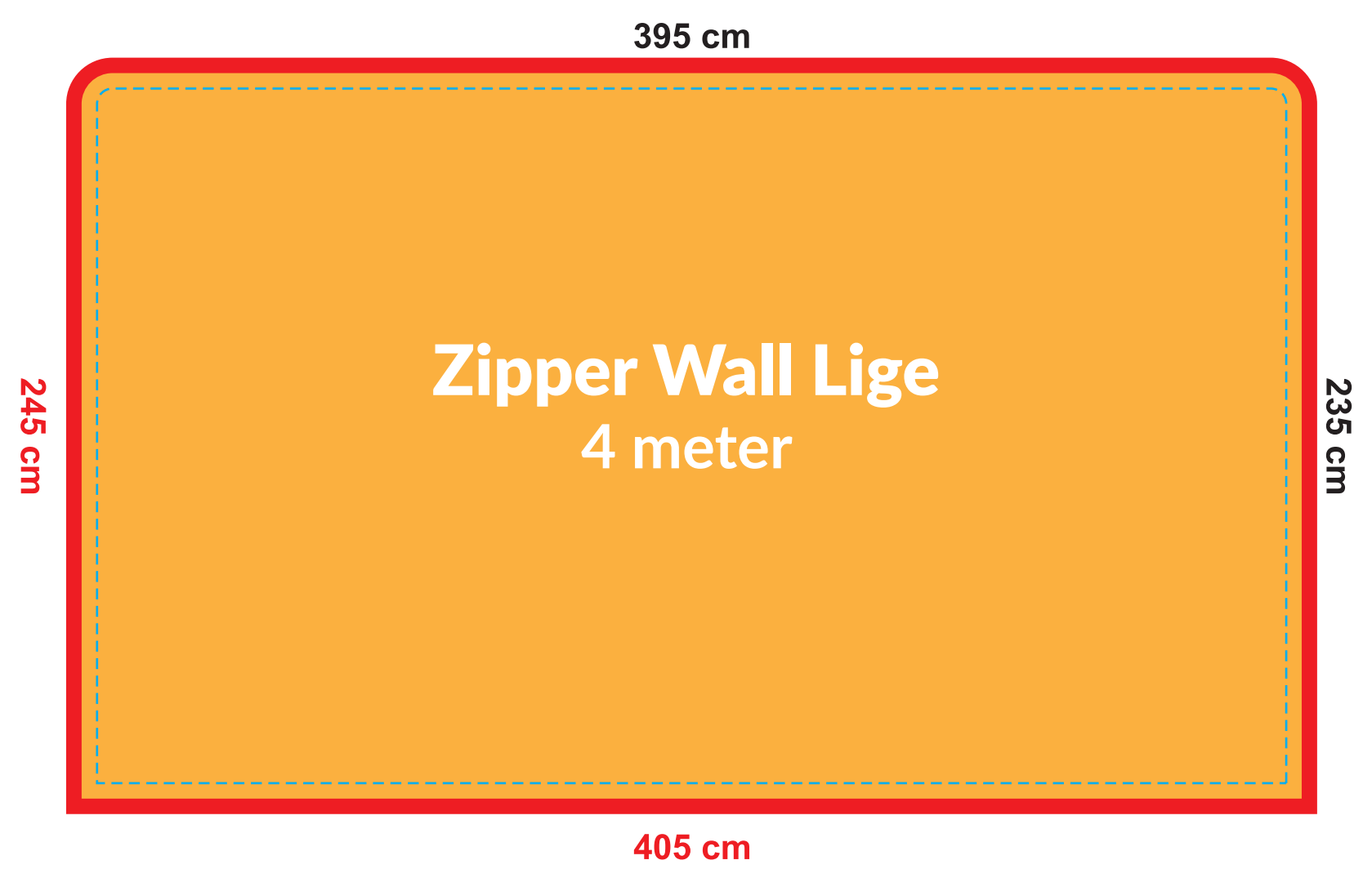
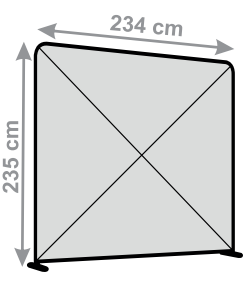
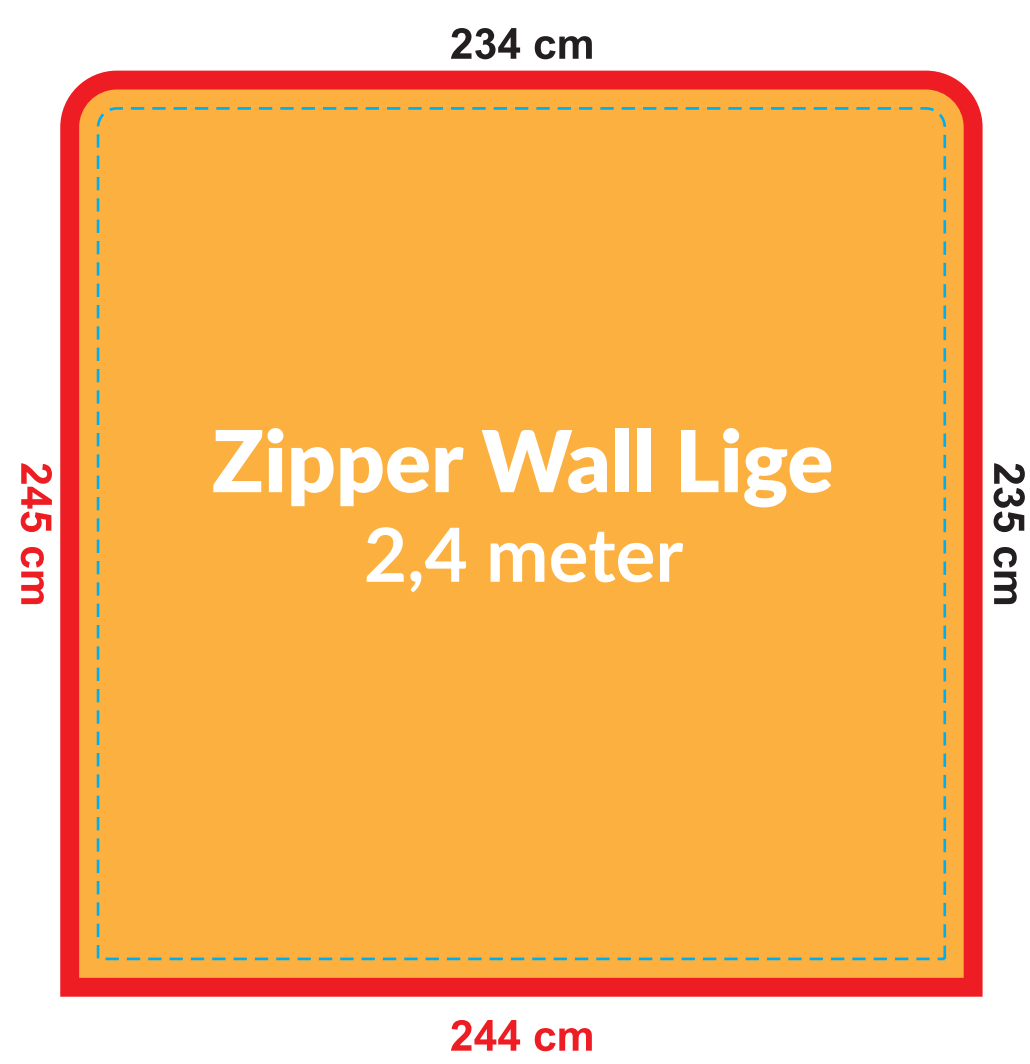

Følg denne skabelon til at designe din Zipper Wall Lav 2 sider for et dobbeltsidet design

Betydningen af farvekoderne:

Primært tryk område

Overlap og sygning

Hold vigtig information indenfor den stiplede linje